



Instructions and Installation

---

**LAMONA**

Exclusive to Howdens Joinery Co.

**Register**   
**my appliance** [www.howdens.com/appliance-registration](http://www.howdens.com/appliance-registration)

---

# Register my appliance

Register your Lamona appliance purchased from Howdens Joinery to allow us to easily contact you in the event of important product updates at:

[www.howdens.com/appliance-registration](http://www.howdens.com/appliance-registration)

## LAMONA

Exclusive to Howdens Joinery Co.

See back page for product serial number

Dear Customer,  
Congratulations on your choice of oven.

**The user manual will help you use your product quickly and safely.**

- Please read this user manual before installing and using the oven.
- Always follow the safety instructions.
- Keep this user manual within easy reach for future reference.
- Please read any other documents supplied with the product.

Explanation of symbols

Throughout this user manual the following symbols are used:



Important information or useful tips about usage.



Warning for possible hazards to health and property.



Warning possibility of electric shock.

Product information correct at the time of publication in January 2017.

The company has a policy of continuous product development and reserves the right to change any products and specifications given in this manual.



This appliance is marked according to the European directive 2012/19/EU on Waste Electrical and Electronic Equipment (WEEE). WEEE contains both polluting substances (which can cause negative consequences for the environment) and basic components (which can be re-used). It is important to have WEEE subjected to specific treatments, in order to remove and dispose properly all pollutants, and recover and recycle all materials.

Individuals can play an important role in ensuring that WEEE does not become an environmental issue; it is essential to follow some basic rules:

- WEEE shall not be treated as household waste.
- WEEE shall be handed over to the relevant collection points managed by the municipality or by registered companies.
- WEEE can be recycled free of charge.

# Index

<b>Before using the oven &amp; Safety</b>	<b>05</b>	<b>Cooking table</b>	<b>14</b>
General	05	Oven cooking table	14
Safety for children	07	<b>Cooking and baking advice</b>	<b>15</b>
Safety when working with electricity	07	<b>Care and maintenance</b>	<b>16</b>
<b>General information</b>	<b>08</b>	General information	16
Oven layout	08	Cleaning the control panel	16
Control panel layout	08	Cleaning the door glass	16
Accessories	08	Removal of the inner door glass	16
<b>Operation modes</b>	<b>09</b>	Replacing the oven lamp	17
Operating modes	09	Removing and cleaning wire racks	17
<b>Preparation</b>	<b>10</b>	<b>Installation</b>	<b>18</b>
First cleaning of the appliance	10	Before installation	18
Initial heating	10	Installation and connection	18
Tips for energy saving	10	Connection to mains supply	19
<b>How to operate the main oven</b>	<b>11</b>	Cooling Fan	20
How to use the main oven	11	<b>Technical specification</b>	<b>21</b>
Select a temperature and operating mode	11	<b>Troubleshooting</b>	<b>22</b>
Shelf positions	11	<b>Your Guarantee</b>	<b>23</b>
Switch off the oven	11		
<b>Clock Programmer</b>	<b>12</b>		
Minute Minder	12		
Timed Operation	12		
Time Stop Point	12		
Delayed Start Cooking	13		

## Before using the Oven

- Make sure that you have removed all packaging, wrappings, stickers and film from the oven's surface (see page 10).
- It is recommended that you clean and wash the oven's surface before using for the first time.



This appliance is for domestic cooking purposes only. It must not be used for other purposes, for example room heating, or drying towels and dish cloths. Commercial use will void the guarantee (see guarantee page).

The manufacturer shall not be liable for any damage caused by improper use or handling errors.

## General Safety

- This product is not intended to be used by persons with physical, sensory or mental disorders or unlearned or inexperienced people (including children) unless they are supervised by a person who will be responsible for their safety or who will instruct them accordingly in the use of the product. Children must be supervised to prevent them from tampering with the product.
- Connect the product to an earthed outlet protected by a fuse of suitable capacity as stated in the "Technical specifications" table. Our company shall not be liable for any problems arising due to the product not being earthed in accordance with the local regulations.
- Do not operate the product if the power cable is damaged. Call qualified service agent.
- Do not operate the product if it is defective or has any visible damage.
- Do not carry out any repairs or modifications on the product. However, you may remedy issues that do not require any repairs or modifications. See Troubleshooting, later in this booklet.
- Never wash down the product with excessive water, as there is the risk of electric shock!
- Never use the product when your judgment or coordination is impaired by the use of alcohol and/or drugs.
- Product must be disconnected from the mains during installation, maintenance, cleaning and repair procedures.
- **Do not place aluminium foil on the base of the baking tray.**
- Repair procedures must always be performed by qualified service agents. The manufacturer shall not be held responsible for damages arising from procedures carried out by unauthorised persons, which may also void the guarantee.
- Be careful when using alcoholic drinks in your dishes. Alcohol evaporates at high temperatures and may cause fire since it can ignite when it comes into contact with hot surfaces.
- Do not heat closed tins and glass jars in the oven. The pressure that would build-up in the tin/jar may cause it to burst.
- Do not place any flammable materials close to the product as the sides may become hot during use.

• **WARNING FIRE RISK: Do not place aluminium foil, baking trays or cook on the base of this oven, doing so will cause permanent damage to your appliance and cabinetry with the potential risk of fire.**

• Keep all ventilation slots clear of obstructions, as this may cause premature failure of the oven element.

• Parts of the appliance may become hot during or immediately after use. Care should be taken to avoid touching the heating elements, and components inside the oven which maybe hot. Always allow sufficient time for the oven to cool.

• Do not allow the oven to cool with the door open. Even if the appliance door is only open a little, front panels of adjacent units could become damaged over time.

• If the door seal is very dirty this can prevent the door from closing properly during use, resulting in possible damage to adjacent furniture and poor efficiency. Always ensure the door seal is clean.

• Always use heat resistant oven gloves when putting dishes in or removing dishes from the hot oven.

• Do not use the product if any door glass is removed or damaged.

• Rear surface of the oven may get hot when it is in use. Make sure that the electrical connections do not contact the rear surface; otherwise, connections may be damaged.

• Do not trap the mains cable and do not route it over hot surfaces. The cable insulation may melt and cause a fire as a result of a short circuit.

• Make sure that the product function knobs are switched off after every use.

• When hot and cold air meet, condensation can form. The outer door is air cooled and the inner glass will become hot during cooking, therefore some condensation might form. This is perfectly normal. All condensation will disappear as the oven reaches cooking temperature.

• Product must be installed by a qualified person in accordance with the regulations in force. Otherwise, the guarantee may become void.

• Do not use harsh abrasive cleaners or sharp metal scrapers to clean the oven door glass since they can scratch the surface, which may result in shattering of the glass.

• Do not use a steam cleaner for cleaning operations.

• **WARNING:** Avoid possibility of electric shock - ensure the appliance is switched off before replacing the lamp.

• The means for disconnection must be incorporated in the fixed wiring in accordance with the wiring rules.

• The instructions state the type of cord to be used, taking into account the temperature of the rear surface of the appliance.

• **Do not switch the oven off at the mains isolation switch immediately after cooking. Cooling fan continues to run for up to 20-30 minutes (approx) even after the oven control is turned off.**

## Safety for children

- Electrical products can be dangerous to children under 8 year of age.
- Keep children away from the product when it is operating and do not allow them to play with or near the product.
- "CAUTION: accessible parts of the oven may become hot when the oven or grill is in use. Children should be kept away until the product has cooled down."
- Do not store any items above the appliance that children may reach for.
- When the door is open, do not load any heavy object on it and do not allow children to sit on it. The door or door hinges may be damaged.
- The packaging materials will be dangerous for children. Keep the packaging materials away from children. Please dispose of all parts of the packaging according to environmental standards.

## Safety when working with electricity

Any work on electrical equipment and systems should only be carried out by authorised and qualified persons.

In case of any damage, switch off the product and disconnect it from the mains. To do this, turn off the fuse at the fuse box.

Make sure that fuse rating is compatible with the product.

# General Information

## Oven layout

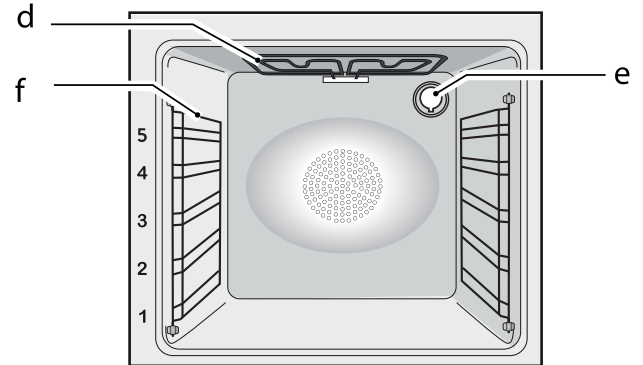
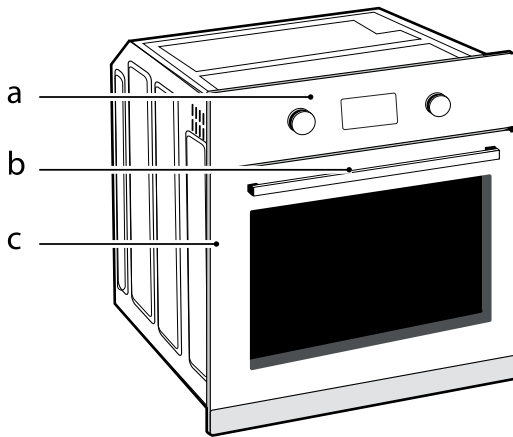

- a. Control panel
- b. Handle
- c. Oven Door

- d. Heating element
- e. Light
- f. Oven shelf positions

## Control panel layout



- a oven / grill function knob
- b Main oven temperature control knob
- c oven /grill temperature indicator

## Accessories

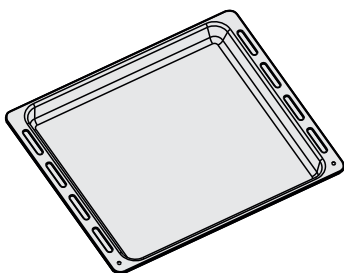

Oven tray / grill pan

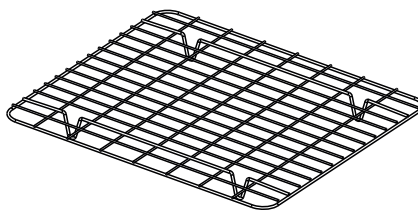

Grill pan wire rack / trivet

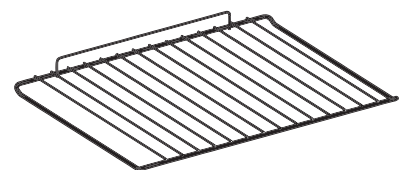

Oven shelf (x2 included)



# Operating modes

## Operating modes

All functions for the ovens and grill are listed in this section. Please note\* depending on the model of your oven, the number and order of operating modes available may deviate from the illustrations shown below.



### Lamp

Turns on the oven light. This will automatically activate the cooling fan.



### Defrosting

When the dial is set to this position. The fan circulates air at room temperature around the frozen foods so that it defrosts in a few minutes without the protein content of the food being changed or altered.



### Circular Heating Element and Fan

Air that has been heated is blown by the fan onto the different levels. It is ideal for cooking different types of food at the same time (e.g. meat and fish) without mixing tastes and smell. It cooks very gently and is ideal for sponge cakes, pastries, etc.



### Grill

Using the top heating element. Success is guaranteed for mixed grills, kebabs and gratin dishes. The grill should be pre-heated to a high temperature for 4 minutes. White meats should always be placed at some distance from the grill element, the cooking time is slightly longer but the meat will be more succulent. Red meat and fish fillets can be placed directly onto the shelf with the drip tray placed beneath on lower shelf position.



### Grill and Fan

The top heating element is used in conjunction with the fan which circulates the hot air around the oven. Pre heating is recommended for red meats but is not necessary for white meats. Grilling is ideal for cooking thicker food items such as pork or poultry. Food to be grilled should be placed directly at the centre of the middle shelf.

By sliding the drip tray underneath the shelf it will ensure that any juices are collected. For best results always make sure that the food is not too close to the grill element and turn the food over half way through the cooking time.

\* Tested in accordance with the CENELEC EN 60350-1 used for definition of energy class.

# Preparation

## First cleaning of the appliance

1. Remove all packaging materials.
2. Wipe the surfaces of the appliance with a damp cloth or sponge and dry with a clean cloth and mild detergent.

The surface may get damaged by some detergents or cleaning materials.

Do not use aggressive detergents, cleaning powder/cream or any sharp objects or abrasives.

## Initial heating

It is recommended to heat up the product for about 30 minutes and then switch it off. Thus, any production residues or layers will be burnt off and removed.

1. Take the tray and the wire grid out of the oven.
2. Close the oven doors.
3. Select the highest oven & grill power levels (See How to use the oven and grill section).
4. Operate oven & grill for about 30 minutes.
5. Turn off your oven & grill and allow to cool.



Small amounts of fumes may emit during the initial heating process; this is normal, however monitor the oven at all times and ensure that the room is well ventilated.

## Tips for saving energy

The following information will help you to use your appliance in an ecological way, and to save energy:

- Use dark coloured or enamel coated cookware in the oven as the heat transmission will be better.
- Perform a preheating operation if it is advised in the user manual or cooking instructions.
- Do not open the door of the oven frequently during cooking.
- Try to cook more than one dish in the oven at the same time whenever possible. You can place two cooking vessels onto the wire shelf.
- Cook one dish after another. The oven will already be hot.
- You can save energy by switching off your oven a few minutes before the end of the cooking time. Do not open the oven door.
- Defrost frozen dishes before cooking them if possible if applicable.

# How to operate the main oven and grill

## Setting the correct time





**WARNING:** The oven will not operate until clock is set.

When first switched on the clock display will flash '12.00'

Touch the + or – buttons whilst the display is flashing to adjust the time. (The display stops flashing after 5 sec and time is displayed).

### To adjust clock time:

Press mode button  x 4 times until clock symbol  is displayed. Touch the + or – buttons whilst display is flashing to set the time of day. (The display stops flashing after 5 sec and time is displayed).

## Select temperature & Operating mode

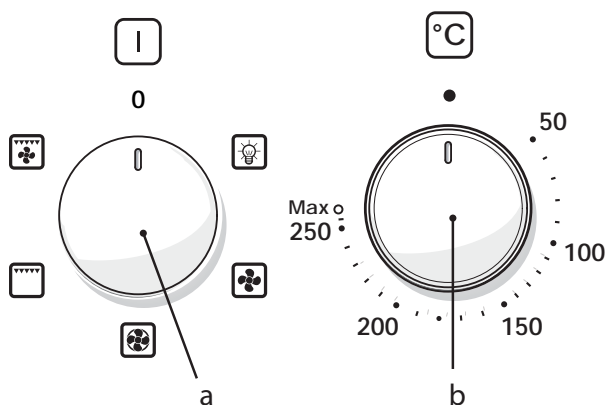

- a. Oven / grill function knob
- b. Oven / grill thermostat knob

The operating modes of the electric oven are selected with the function knob. The temperature is adjusted with the thermostat knob.

## How to use the Oven & Grill

1. Set thermostat knob to the desired temperature.
2. Set function knob to the required operating mode.
3. **Close the oven door**

The oven heats up to the adjusted temperature and maintains it. During heating, the temperature indicator light will remain on until the desired temperature is reached.

## Shelf positions

The oven has 5 shelf positions as illustrated below, It is important to position the wire shelf into the runners correctly.

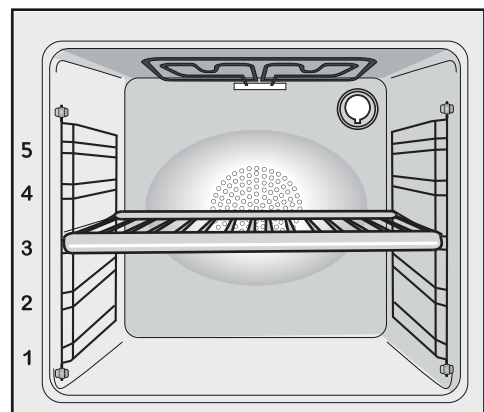

Please ensure shelves are fully inserted before closing the oven door, failure to do so could lead to damage to the door.

**Warning** -Do not place aluminium foil or baking trays on the base of the oven. This can lead to permanent damage to your appliance.

**Warning** –Do not place plates, dishes or trays on the floor of oven cavity when oven is in use.

**Warning** - Do not use the oven or grill cavity for storage when not in use.



## Switch off the electric oven

Turn function knob and thermostat knob to off position (top).



# Clock Programmer

## Minute Minder (0.01 min - 23.59hr)



Press mode button  x 1 times until alarm symbol  is displayed. Touch the + or – buttons to set the desired time duration. The alarm will sound when the selected time has elapsed. Touch any button to stop alarm

To Cancel:



Press mode button  x 3 times until alarm symbol  is displayed. Touch the + or – buttons to set the duration to 00.00.

## Timer Cooking

### Timed Operation Period

Oven cooks for a selected time period then stops: (0.01min to 23.59 hr)



Press mode button  x 2 time until Cook symbol  is displayed and flashing.

Touch the + or – buttons to set the desired cooking time duration. (Display reverts to time of day after desired time period is set and  + **A** symbol remains lit)

Select desired oven cooking mode and temperature using the oven control knobs.



The alarm will sound and the Cook symbol  will flash when the selected cooking time has elapsed.

Turn oven control knobs to 'Off' and touch any button to stop alarm and return oven to 'Manual' use mode.

**To Check time left:**

Press mode button  x 2

**To Cancel:**

Press mode button  x 1 time until Cook symbol  is displayed.

Touch the + or – buttons until alarm sounds and display shows 00.00. Clock time returns.

**Note: Whilst cook symbol  is flashing the oven cannot be used in 'Manual' mode.**

### Time Stop Point

Oven cooks until a designated time then stops: (up to 23.59 hr)



Press mode button  x 2 times until symbol **A** is displayed and flashing.

Touch the + or – buttons to set the desired stop time. (Display reverts to time of day after desired stop time is set and **A** +  symbol remains lit).

Select desired oven cooking mode and temperature using the oven control knobs.

The alarm will sound and the  symbol will flash when the selected time has been reached.

Turn oven control knobs to 'Off' and touch any button to stop alarm and return to 'Manual' use mode. (Timer will sound for 2 mins then stop if no button is pressed).

**To Cancel:**

Press mode button  x 2 times until **A** symbol is displayed.

Touch the + or – buttons until **A** flashes, alarm sounds and time of day returns.

(Timer sounds for 2 mins then stops if no button is pressed).

## Delayed Start Cooking

The two timed cooking modes can be combined to create a delayed start cooking period.

### Programme a Timed Operation Period

(as described on p12).

Then

### Programme a Time Stop Point

(as described on p12).



Both symbols **A** and  will be displayed and the cooking process will start at a future point in time e.g.

If Time Stop Point is set to 16.00 and Timed Operation Period is set to 1.30 hrs  
 - The oven will switch on at 14.30 and cook until 16.00

### To Check Settings:

Push mode button  x 2 to see  cooking period.

Push mode button  x 3 to see **A** cooking end time.

### To Cancel:

Press mode button  x 2 time until Cook symbol  is displayed.

Touch the + or – buttons until alarm sounds and display shows 00.00 Clock time returns.

## Key Lock

### How To Use

Child Lock function is activated by touching Set + for a minimum of 5 seconds. From this moment on all other function are locked and the display will flash STOP and preset time intermittently.

### How To Deactivate





















Child Lock function is deactivated by touching touchpad Set + again for a minimum of 5 seconds. From this moment on all functions are selectable again.

# Cooking Tables

 The values indicated in the tables below are indicative. They may vary according to the type of food, the quantity and your preferences of cooking.

 **Baking and roasting**  
Level 1 is the lowest shelf level.

## Oven cooking table

Food	Cooking level number	Oven Function	Rack position	Temperature °C	Cooking Time min.
<b>Cake in tray</b>	One level		3	175	30...40
	2 levels		2 - 3	175	45...60
<b>Cake in mould</b>	One level		2	175	50...60
<b>Cake in paper</b>	One level		3	175	25...35
	2 levels		2 - 3	175	35...45
	3 levels		1 - 2 - 3	180	45...55
<b>Sponge cake</b>	One level		3	200	15...20
<b>Cookies</b>	One level		3	175	25...30
	2 levels		2 - 3	170...190	35...45
	3 levels		1 - 2 - 3	175	30...40
<b>Dough pastry</b>	One level		3	200	35...45
	2 levels		2 - 3	200	50...60
	3 levels		1 - 2 - 3	200	55...65
<b>Filled savoury pastry</b>	One level		3	200	25...35
	2 levels		2 - 3	200	35...45
	3 levels		1 - 2 - 3	190	45...55
<b>Leaven</b>	One level		3	200	35...45
<b>Lasagne</b>	One level		3	200	30...40
<b>Beefsteak (whole)/Roast</b>	One level		3	25 min. 250 after 180...190	100...120
<b>Lamb haunch (casserole)</b>	One level		3	25 min. 220 after 180...190	70...90
<b>Roast chicken</b>	One level		2	15 min. 250 after 190	55...65
<b>Turkey (5.5kg)</b>	One level		1	25 min. 250 after 190	150...210
<b>Fish</b>	One level		3	200	20...30

While cooking with 2 trays at the same time, place the deep tray to the upper shelf and shallow tray to the lower shelf.

It is suggested to perform preheating for all foods.

# Cooking and baking advice



Risk of scalding by hot steam! Take care when opening the oven door as steam may escape.

## Tips for baking

- Use nonstick coated appropriate metal trays and containers or heat-resistant silicone moulds.
- Make best use of the space on the shelf.
- It is recommended to place the vessels in the middle of the shelf.
- Select the correct shelf position before turning the oven or grill on - don't move oven shelves when hot.
- Keep the oven door closed.

## Tips for roasting

- Seasoning with lemon juice and black pepper will improve the cooking performance when cooking a whole chicken, turkey or a large piece of meat.
- Meat with bones takes about 15 to 30 minutes longer to cook than a roast of the same size without bones.
- Let meat rest in the oven for about 10 minutes after the cooking time. The juices will be better distributed throughout the meat and will not run out when the meat is cut.
- Fish in a heat proof dish should be placed at the medium or lower level.

## Tips for grilling

- Grilling is ideal for cooking meat, fish and poultry and will achieve nice browning without drying out the food. Flat pieces, meat skewers and sausages are particularly suited for grilling, as are vegetables with a high water content, such as tomatoes and onions.
- Distribute the pieces to be grilled on the wire rack.
- Use tray or grill pan under the wire rack in order to collect dripping fat or juices.
- Adding some water to the grill pan will assist with cleaning.

## Tips for baking cake

- If the cake is too dry, increase the temperature by 10°C and decrease the cooking time.
- If the cake is wet, use less liquid or lower the temperature by 10°C.
- If the cake is too dark on top, place it on a lower shelf, lower the temperature and increase the cooking time.
- If cooked well on the inside but sticky on the outside use less liquid, lower the temperature and increase the cooking time.

## Tips for baking pastry

- If the pastry is too dry, increase the temperature by 10°C and decrease the cooking time. Dampen the layers of pastry with a wash composed of milk, oil, egg.
- If the pastry takes too long to bake, pay attention to the thickness of the pastry you have prepared
- If the upper side of the pastry gets browned, but the lower part is not cooked, make sure that the amount of wash you have used for the pastry is not too much at the bottom of the pastry. Try to spread the wash equally over the pastry for an even browning.
- Cook the pastry in accordance with the mode and temperature given in the cooking table.

## Tips for cooking vegetables

- If the vegetable dish runs out of juice and gets too dry, cook it in a dish with a lid instead of an open tray. Closed vessels will preserve the juice of the dish.
- If a vegetable dish is not cooked, boil the vegetables beforehand.

# Care and maintenance

## General information

Service life of the product will extend and the possibility of problems will decrease if the product is cleaned at regular intervals.



### Risk of electric shock!

Switch off the electricity before cleaning appliance to avoid possibility of an electric shock.



### Hot surfaces may cause burns!

Allow the appliance to cool down before you clean it.

- Clean the product thoroughly after each use. This way it will be possible to remove cooking residues more easily and will avoid burning them on the next time the appliance is used.
- No special cleaning agents are required for cleaning the product. Use warm water with washing liquid, a soft cloth or sponge to clean the product and wipe with a dry cloth.
- Always ensure any excess liquid is thoroughly wiped off after cleaning and any spillage is immediately wiped dry.
- Do not use cleaning agents that contain acid or chloride to clean the stainless steel surfaces and the handle. Use a soft cloth with a liquid detergent (not abrasive) to wipe those parts clean, paying attention to sweep in a horizontal direction.



The surface may be damaged by some detergents or cleaning materials.

**Do not** use aggressive detergents, cleaning powder/cream or any sharp objects.

**Do not** use steam cleaners for cleaning.

## Cleaning the control panel

Clean the control panel and control knobs with a damp cloth and wipe them dry.



**Do not** remove the control knobs for control panel cleaning.

## Cleaning oven door glass

Don't use any harsh abrasive cleaners or sharp metal scrapers for cleaning the oven door. They could scratch the surface and damage the glass.

## Removal of the oven door glass

1. Open the door.
2. Unlock the door by moving the clips at the hinge: lift and move backwards as illustrated below:

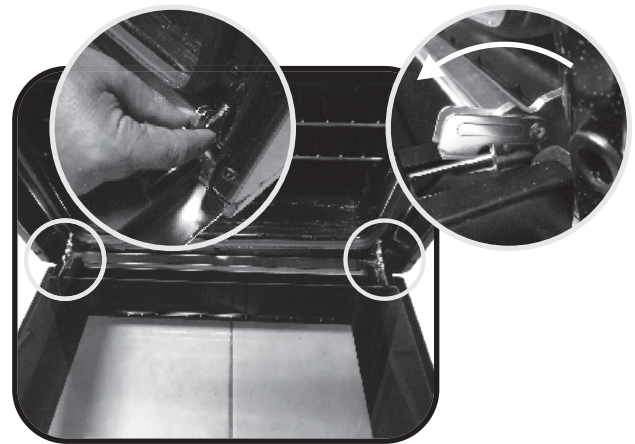

3. Remove the screws as shown below:

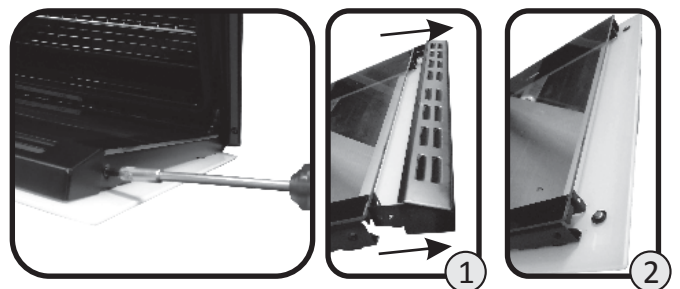

4. Remove the top cover by pulling it up-wards (1) leaving the inner glass free to remove (2).
5. Remove the glass by gently pulling it out of the frame and clean.

**Do not** place the door or inner glass panel on rough or hard surfaces. Handle with care during removal, cleaning and refitting

Steps carried out during removing process should be performed in reverse order to replace the glass.



Do not forget to lock the clips at the hinges when cleaning is complete.



## Replacing the oven lamp



### Hot surfaces may cause burns!

Make sure that the appliance is switched off and cooled down in order to avoid the risk of an electrical shock or burns.



The oven lamp is a special electric lamp that can resist up to 300 °C. See Technical specifications, for details.



Position of lamp might vary from the diagram.

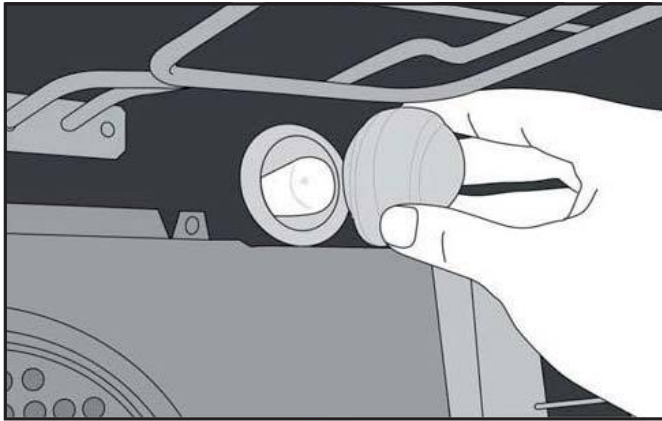

1. Disconnect the product from mains.
2. Turn the glass cover counter clock-wise to remove it.
3. Remove the oven lamp by turning it counter clockwise and replace it with the new one.
4. Install the glass cover

## Removing and cleaning wire racks

- 1- Remove the wire racks by pulling them in the direction of the arrows (see below)
- 2- To clean the wire racks either put them in the dishwasher or use a wet sponge, ensuring that they are dried afterwards.
- 3- After the cleaning process install the wire racks in reverse order.

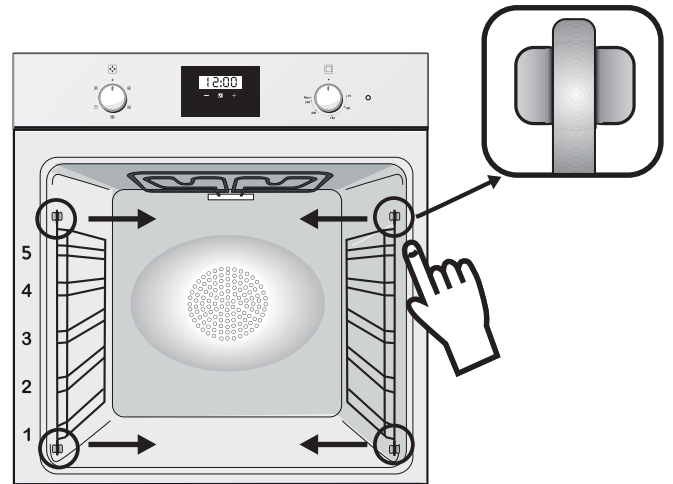

# Installation

## Before installation

The product should only be installed by suitably qualified persons.



The product must be installed in accordance with all local regulations.



Prior to installation, visually check the product for any damage/defects. Do not install if any issues are found.

Damaged products may cause risks to your own safety.

The appliance is intended for installation in Howdens kitchen cabinets.

- Surfaces, synthetic laminates and adhesives used must be heat resistant.
- Kitchen cabinets must be set level and fixed.
- If there is a drawer beneath the oven, a shelf must be installed between oven and drawer.
- The following installation drawings are representational and may not match exactly with your appliance.

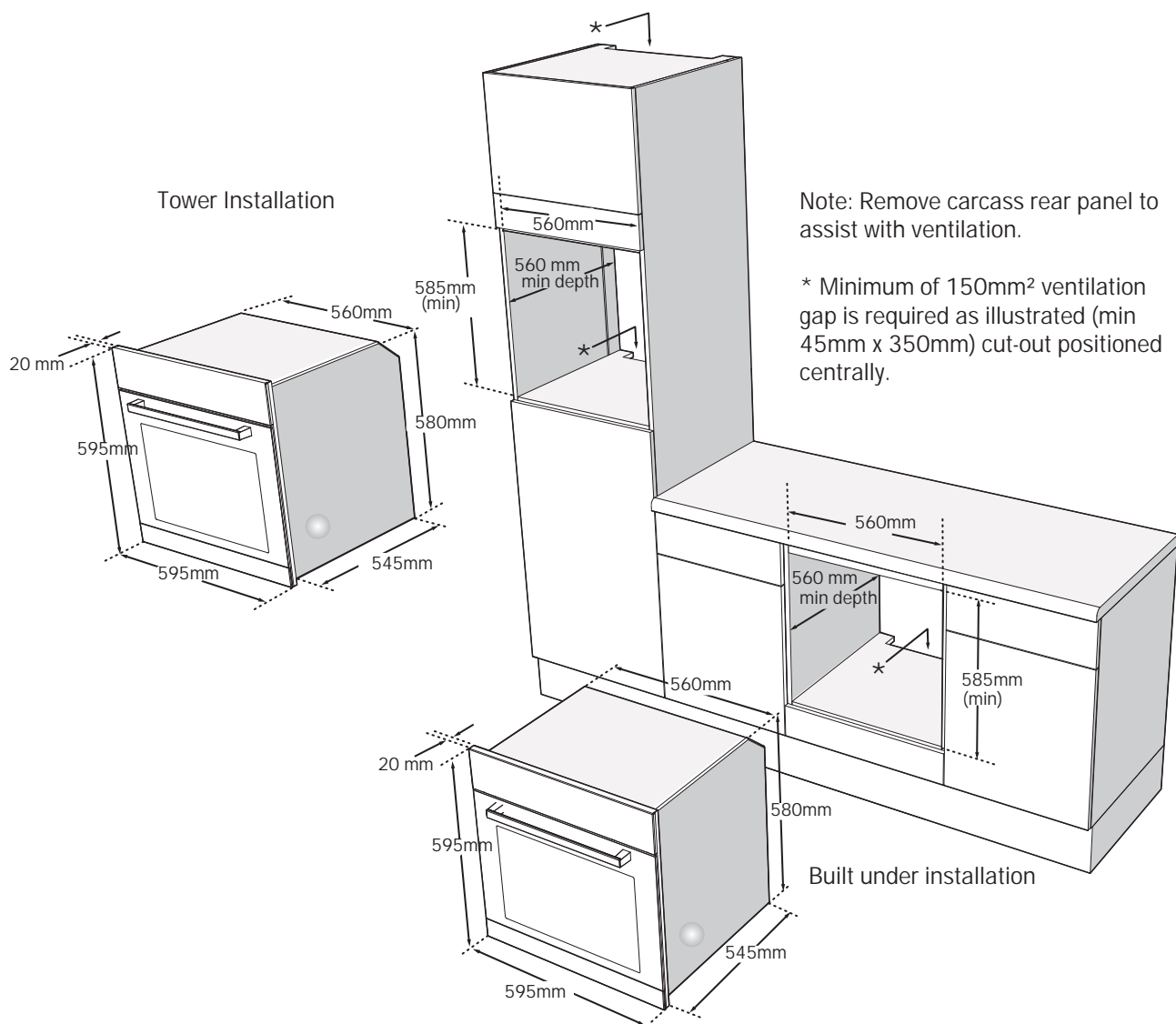

## Electrical Connections



**IMPORTANT:** Ensure that the electricity supply is switched off before connecting. Your oven is intended for permanent installation.

Your appliance must be connected to fixed wiring via the use of a double pole switched fused spur outlet with at least 3mm contact separation. The isolation switch must be accessible after installation (see technical data for fuse rating). We recommend the use of an RCD device as additional protection.

We strongly recommend the appliance is connected by a qualified electrician who is a member of the N.I.C.E.I.C who will comply with the I.E.E and any local regulations.

The terminology DOUBLE POLE -/+ means that both the live and neutral supplies are switched and disconnected at the same time.

The terminations labelled SUPPLY are connections for the internal house wiring and the terminations labelled LOAD are for connection to the appliance.

**IMPORTANT:** The wires in the mains lead are coloured in accordance with the following code:-

Blue..... Neutral

Brown.....Live

Green and Yellow.....Earth

As the colours of the wires in the mains lead of this appliance may not correspond with the coloured markings identifying the terminals in your spur box, proceed as follows;

The wire which is coloured blue must be connected to the terminal which is marked with the letter 'N' or coloured 'BLACK'. The wire which coloured brown must be connected to the terminal which is marked with the letter 'L' or coloured RED. The green and yellow earth 'E' should be connected to the terminal marked with the following symbol '⊕'

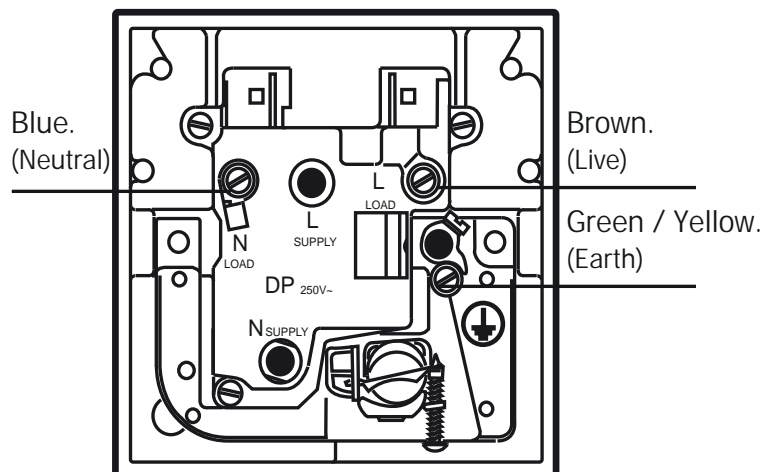

The appliance may be connected to the mains supply only by a competent person. The mains lead must not be clamped, bent, trapped, or come into contact with hot parts of the appliance.



If the mains lead is damaged, it must be replaced by a qualified person (mains cable must not be longer than 2m for safety reasons). It should be routed away from the appliance and not trapped between the appliance and the wall.

Your oven comes prefitted with a mains cable. If you need to change it:

1. Open the terminal block cover with screwdriver.
2. Pass the mains lead under the cable clamp and secure clamp with the screw over the outer cable insulation.
3. Connect the cables according to the supplied diagram.
4. Close the cover of the terminal block once the wiring is complete.
5. Mains cable must not be longer than 2 metres for safety reasons.
6. The mains lead should be routed away from the appliance and not be trapped between the appliance and the wall.

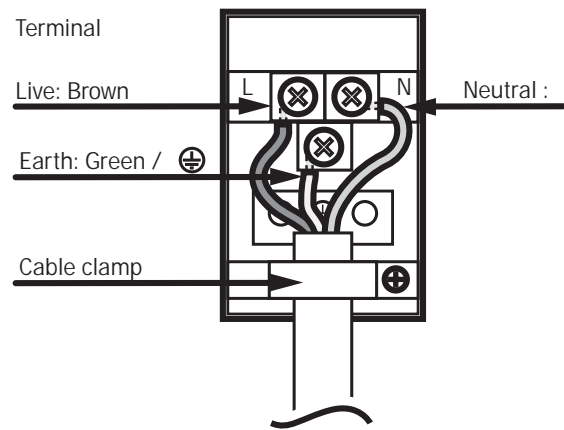

### Installation

Slide the oven into the cabinet aperture, align and secure.

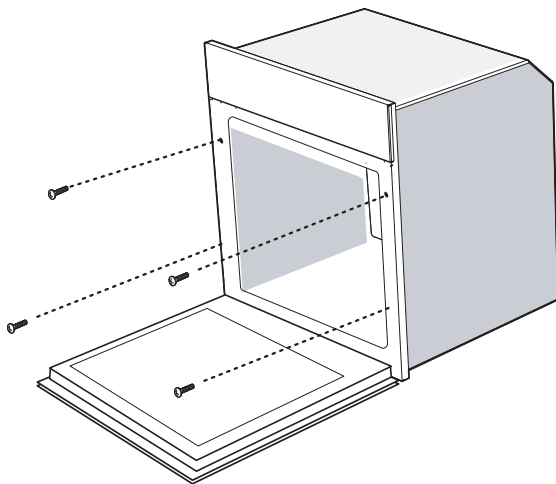

Fix your oven with 4 screws and retainers.

### Final check

Connect the appliance to the mains supply, switch on the mains supply and check the oven's functions,

### Cooling fan

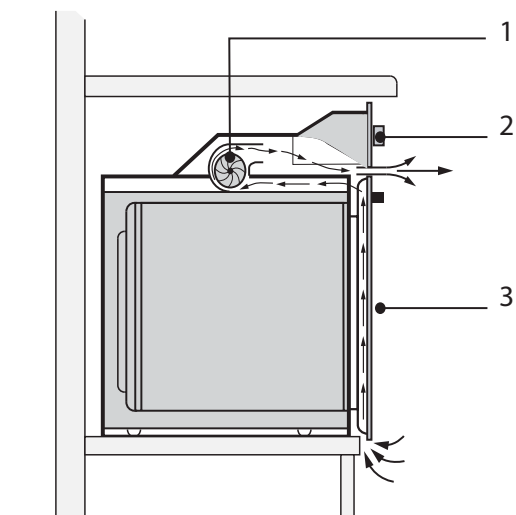

- 1- Fan
- 2- Control panel
- 3- Door

The Built-in cooling fan cools both the front of the appliance and cabinetry.



**Do not switch the oven off at the mains isolation switch immediately after cooking. Cooling fan continues to run for up to 20-30 minutes (approx) even after the oven control is turned off.**

## Technical specification

TECHNICAL INFORMATION	
General	
Voltage /Frequency	220-240 V ~ 50 Hz
Total power consumption	2.1kW
Fuse	min. 13A
Oven/Grill	
External dimensions (height / width / depth)	595 mm/595 mm/545mm
Installation dimensions (height / width / depth)	585-595 mm/560 mm/min. 560 mm
Main oven	Fan Oven
Energy efficiency class#	A
Energy consumption	0.85 kW/h
Inner lamp	240 V/15-25 W/E14 SES/T 300 °C
Mains Cable	H05W-F 1.5mm <sup>2</sup> (1.5m)

# Basics: Information on the energy label of electrical ovens is given in accordance with the EN 60350-1 standard. Those values are determined under standard load with bottom-top heater or fan assisted heating (if any) functions.

Energy efficiency class is determined in accordance with the following prioritization depending on whether the relevant functions exist on the product or not. 1-Cooking with eco-fan, 2- Turbo slow cooking, 3- Turbo cooking, 4- Fan assisted bottom/top heating, 5-Top and bottom heating.

\*\* See. Installation section.

- Technical specifications may be changed without prior notice to improve the quality of the product.
- Figures in this manual are schematic and may not exactly match your product.
- Values stated on the product labels or in the documentation accompanying it are obtained in laboratory conditions in accordance with relevant standards. Depending on operational and environmental conditions of the product, these values may vary.

# Troubleshooting

TROUBLESHOOTING GUIDE		
Symptoms	Possible Cause	Solutions
<b>Oven emits steam when it is in use.</b>	<ul style="list-style-type: none"> <li>Food is being cooked with a high water content</li> </ul>	It is normal that steam escapes from food during cooking. This is not a fault.
<b>Product emits metal noises while heating and cooling.</b>	<ul style="list-style-type: none"> <li>When the oven cavity heats up or cools down parts will expand and contract.</li> </ul>	This is quite normal and the oven is designed to accommodate such movement (this is not a fault).
<b>Product does not operate</b>	<ul style="list-style-type: none"> <li>The mains fuse maybe defective or has tripped</li> <li>Product is not connected properly. Check all power connections.</li> </ul>	Check fuses in the fuse box. If necessary, replace or reset them.
<b>Oven light does not work.</b>	<ul style="list-style-type: none"> <li>Oven bulb is defective Replace oven bulb</li> <li>Power is cut.</li> </ul>	Check if there is power. Check the fuses in the fuse box. If necessary, replace or reset the fuses.
<b>Oven does not heat.</b>	<ul style="list-style-type: none"> <li>Function and/or Temperature are not set.</li> <li>The timer is not adjusted correctly Reset the oven timer.</li> <li>Power is cut.</li> </ul>	Set the function and the temperature with the Function and/or Temperature knob/key.  Check if there is power. Check the fuses in the fuse box. If necessary, replace or reset the fuses.



If you cannot eliminate the problem after following the instructions in this section, consult your depot or the Authorized Service Agent. Never try to repair a nonfunctional product yourself.

# Your guarantee

## Product Guarantee Details (UK only)

---

**Your appliance has the benefit of a comprehensive manufacturer's guarantee which covers the cost of breakdown repairs. (Details of which are shown on your Proof of purchase Document).**

- Any claim during the period of the guarantee MUST BE ACCOMPANIED BY THE PROOF OF PURCHASE.
- The product must be correctly installed and operated in accordance with the manufacturer's instructions and used for normal domestic purposes.
- This guarantee does not cover accidental damage, misuse or alterations which are likely to affect the product.
- The guarantee is invalid if the product is tampered with, or repaired by any unauthorised person.

*(The guarantee in no way affects your statutory or legal right)*

## What to do if you need to report a problem.

Please ensure you have ready:

- The product's model and serial numbers.
- Howdens Proof of Purchase Document.
- Your full contact details.

**Call the Depot number on your Proof of Purchase Document supplied with the product / kitchen.**

**or**

**Call the LAMONA Service Line on 0845 00 60 006**

\*Product installed within a domestic kitchen or a non-domestic kitchen where 8 or fewer people are using the appliance.

<b>Where to find the model and serial number on your machine.</b>	<b>Open door on the panel just below the door seal</b>
---	--





## Product Fiche

Commission Regulation (EU) No 65/2014

Model	LAM3406
Type of Oven	Fan Oven
EEl <sub>cavity</sub>	101.2
EEl <sub>class</sub>	A
EC <sub>electric cavity</sub>	0.85kWh/cycle
Number of cavities	1
V	69L

## Product Information

Commission Regulation (EU) No 66/2014

Model	LAM3406
Type of Oven	Fan Oven
M	27kg
Number of cavities	1
V	69L
EC <sub>electric cavity</sub>	0.85kWh/cycle
EEl <sub>cavity</sub>	101.2



03.2017 • 42821133 \_ Rev\_A

Product serial number  
(Place sticker here)

**LAMONA**  
Exclusive to Howdens Joinery Co.

ISSUE v2 070317